



F&F Filipowski sp. j.
ul. Konstytucyjna 79/81
95-200 Pabianice POLAND
tel/fax 48 42 2270971
e-mail: fif@fif.com.pl

EPS-D

MICROPROCESSOR-BASED RELAY FOR ELECTRIC ENGINES



www.fif.com.pl

F&F products are covered by an 24 months warranty from date of purchase

Information of safety use of multimeter are identified by symbols. All information and recommendations bearing these symbols should be strictly observed.



Danger of electric shock.



The potentially dangerous situation which could lead to threats to personnel or damage to the operating of multimeter.

These characteristics are assigned with particular classes within the range from 5 to 40 (each class is a function which describes time in seconds after the lapse of which the relay will disconnect the current load at the multiplicity of $7,2 \times$ its set current I_r). The proper characteristics are selected depending on the start-up parameters and rated power of the engine. On the grounds of the protection characteristics selected, as well as the whole "history" of the engine's operations from the moment the relay was activated, the EPS calculates the maximum permissible engine overload time in order not to exceed the temperature rise threshold value, and disconnects the engine power supply once the value has been exceeded. Thanks to advanced processing algorithms applied, the EPS also correctly measures the actual effective value of currents deformed by higher harmonics (including the 7th harmonics), even with considerable overcurrents (up to 10 times). The thermal protection offers two operation modes: manual and automatic.

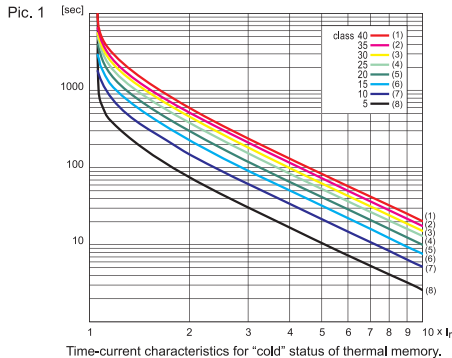

Information concerning the construction, operation and maintenance of relay.



Important information, a valuable tip.



Practical advice, solve the problem.



An example of the use or performance.

PURPOSE

The EPS is intended for the protection of triple-phase electric engines of any power rating (for engines with power between several hundred watts and 55kW, direct connection may be used, whereas more powerful units require additional, external current transformers). The EPS secures the engine against thermal and current overloads, ground faults, faults leading to engine rotor stall, as well as against heavy start-up conditions, load unbalance and phase collapse. The EPS is also a perfect solution for engines used in expensive applications which require high reliability, like lifts, conveyors, elevators, fans, centrifuges, compressors, etc.

DESCRIPTION OF PROTECTION DEVICES

- thermal protection

The relay controls load imposed on each phase. Based on the set values selected by the operator, as well as on the actual current consumed by the engine, the microprocessor utilises one of the eight time-current characteristics of the relay in accordance with the IEC947 standard (see picture. 1).

- protection against frequent start-ups

Thanks to the electronic "heat accumulation" feature, the device stores the temperature condition of the engine working in safe conditions. Frequent start-ups lead to extremely intensive heat generation in the engine, which in turn causes its overheating. In order to avoid this, after the set temperature rise has been achieved, the relay disables further start-ups until the temperature drops below the maximum permissible level.

- protection against load unbalance and phase decay

Independent current measurement for each phase enables the situation in which any phase collapse or operation with load unbalance exceeding 30% will be detected early enough, and the engine will be turned off with a 4-second delay. The delay is to avoid engine disconnection each time the voltage drops momentarily due to minor network fluctuations.

- protection against ground fault

Ageing electric cable insulation is one of the most common causes of punchthrough to the relay's case which may lead to ground faults dangerous for the engine and people in its proximity. In order to avoid this, the EPS relay has been equipped with a feature which selectively detects ground faults at the level predefined by the user and disconnects the engine after the lapse of a set time. This feature does not require any additional current transformer.

ATTENTION!



The above function does not serve to protect operators against electric shock and is only intended as a fire-prevention measure!



- protection against shock or fire

Using an additional transformer Ferrnatiogo EPS enables the security of the passage currents up from 30mA to 50mA and activation time around 100 ms, which can provide additional service protection against electric shock .

- control of the growth of the motor current

Holdinging it, even slightly, exceeding the rated current may be a malfunction of the engine. If such a state will be maintained for a specified period of time, this feature allows you to disable the engine being hedged.

- control of the motor current reduction

Protection against reduction of the motor current below the level of continuing for a specified period of time prevents the engine idle. This feature can be used such as effective protection against dry-run of pumps.

- control of correct phase sequence currents

This feature prevents the engine from running when you connect the phases in the wrong sequence.

FUNCTIONING

On the basis of continuous load measurement made by internal current transformers, the EPS relay simulates the temperature status of the engine working in safe conditions and compares it to the set current-time protection characteristics. In addition, thanks to advanced processing algorithms applied, the EPS correctly measures the actual effective value of currents deformed by higher harmonics, even with considerable overcurrents (up to 10 times). Each time the set protection parameters are exceeded, e.g. in cases of engine overheating, phase collapse, voltage unbalance or ground fault, the 95-96 contact will be opened and the engine will be switched off.

table 1

Setting	Min.	Max.	Setting change
I_n	4A	20A	0,5A
I_z	20A	800A	0,5A
t_z	0,4s	5s	0,02s
t_d	0s	5s	0,02s
I_g	2A	100A	0,5A
t_g	0,4s	5s	0,02s
I_u	3,5A	100A	0,5A
t_u	0,4s	5s	0,02s
Rank	5	40	5
t_r	0,03A	0,5A	0,01A
Mode	auto	manual	

- I_n - rated current of engine ¹⁾
- I_z - current of short-circuit protection
- t_z - delay for short-circuit protection
- t_d - dead time for short-circuit protection²⁾
- I_g - current of ground-short-circuit protection
- t_g - delay for ground-short-circuit protection ³⁾
- I_u - current of under-current protection⁴⁾
- t_u - delay for under-current protection⁴⁾
- Rank - Characteristics of current-time security ⁵⁾
- Mode - Work mode for therms protection ⁶⁾
- I_r - curent of residual-current protection
- Mode - Work mode for therms protection ²⁾

The relay will signal the cause of the disconnection. The engine can be restarted only after the cause of the defect has been rectified or proper power supply conditions reinstated. The operator must also unblock the relay manually (with the reset button). In the event of the thermal protection activated in the manual operation mode, the engine may be restarted after its temperature drops below 80% of the maximum permissible value. On the other hand, in the automatic mode, the engine will be restarted automatically after its temperature drops below the value stated above.



The EPS relay has a feature of electronic "heat accumulation", i.e. during the engine's continuous work, the device stores the temperature of the engine working in safe conditions, and once the relay is disconnected from the power supply or in the event of power voltage decay, its "thermal memory" is cleared and returns to the initial, "cold" status.



Due to the deformities in current flows caused by rotational speed inverters and the soft-starters included in the system, the EPS cannot be connected to such devices at the output side.

SELECTION AND PARAMETERS OF RELAY

EPS is produced in two current versions: for rated currents from 4A to 20A, and for rated currents from 20A to 100A. A summary of all parameters is presented in Table 1

- 1) The engine is properly protected, if the current work does not differ by more than $\pm 5\%$ from set rated current of relay.
- 2) To allow the engine to properly start you can further increase the delay activation of short-circuit protection by providing additional dead time counted during enclose the relay or failure to remove
- 3) ATTENTION! Time 400ms is the minimum required exclude time at short-circuit ground fault.
- 4) Protection could be turn OFF if $I_u \square I_n$
- 5) Selecting one of the eight characteristics of thermal protection in the range of 5 + 40 (Pic. 1). Class functionally determines the time after if relay off the overload of 7.2 times its set current .
- 6) auto - automatic operation ensures automatic return to work for the relay response thermal protection, both for the simulation of temperature and temperature by thermistors. Back in the simulation when simulated temperature is lower by 20% compared to nominal.

table 2

P.[kW]	0,75	1,1	1,5	2,2	3,0	4,0	5,5	7,5
I_n [A]	1,8	2,7	3,5	5,0	6,5	8,0	11	15
P.[kW]	11	15	18,5	22	30	37	45	55
I_n [A]	22	30	34	41	55	68	81	99



Selection EPS for the engine being hedged, remember that engines operating in the propulsion system are selected so as to achieve an approximately 80% of their nominal values.

Selection of the appropriate characteristics of security make a based on the data engine of manufacturers. In the absence of such data, we can use the tables 3 and 4 with data indicative of a security class, depending on the time of engine starting.

table 3

DIRECT START	
start time	class
1+2 sec	5, 10
3+5 sec	10, 15
6+8 sec	20, 25
9+10 sec	30, 40
>10 sec	40

table 4

STAR-DELTA START	
start time	class
5+10 sec	5, 10
15 sec	15
20+25 sec	20, 25
30 sec	30
30+40 sec	35, 40



Thermal protection class is selected for the engine operation in normal conditions (ambient temperature 20 °C).

In the case of high ambient temperatures caused, for example, weather or engine failure ventilated slowly gives the cumulative heat. For such cases you must set a lower class of security that there is no overheating of the engine.

Pic. 2

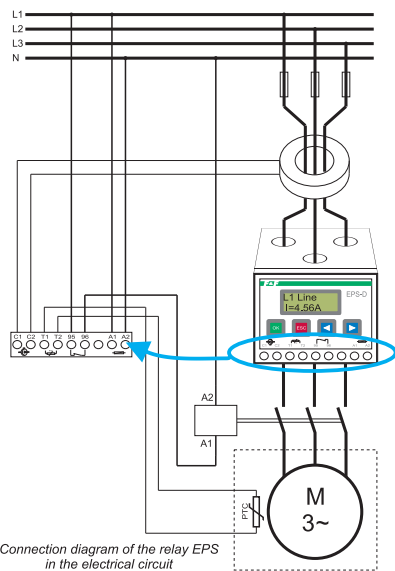

Connection diagram of the relay EPS in the electrical circuit

ATTENTION!



User is responsible for adequate grounding system, proper selection, installation and performance of other devices.



ASSEMBLY

ATTENTION!



The EPS relay should be assembled, operated and regulated only by personnel qualified in its structure, function and all related hazards.



ATTENTION!



Do not install damaged or incomplete relays!



1. Check if the engine works properly.
2. Disconnect the power supply.
3. Put the EPS in the switchgearbox on the rail TH-35.

ATTENTION!



The EPS should be mounted in cases with IP42 protection level.



4. The engine's power supply cables (see pic. 2) through the apertures in the upper wall of the relay.

ATTENTION!



Leads and connect the wires after making sure that the power supply is disconnected.



In the case of a STAR - DELTA start to mount the relay (in the sense of electric) are always the main contactor (pic. 3).

Pic. 3

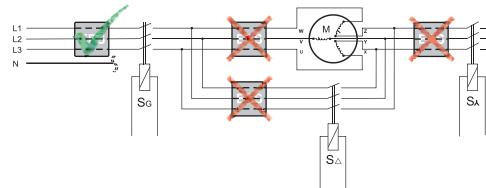

Places of connection EPS in switch system STAR - DELTA

5. To joints A1-A2, connect the power of relay. Use second-class protection for overvoltage (level load). (Pic. 2)
 6. Joints 95-96 connect in series in system of coil of contactor which enclose the engine. (Pic.2)
- ATTENTION! Load of joints may not exceed the values given in the rated data..**
7. Joints C1 and C2 connect to transformer Ferrantiago of type Tr250, TR400 or TR630 (if its needed). When transformer isn't connected then joint will stay open.
 8. Joints T1 and T2 connect to the termistor sensors mounted in engine winding. Maximum can be connected in series to six sensors.





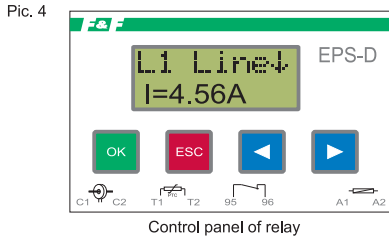

In the case of not use the termistor security, joints T1 and T2 to be shorted by resistor 2kΩ.

HANDLING

Handling of EPS-C relay is implemented through the operator panel, consisting of a double rows LCD display and four button keypad.



Buttons in the steering panel have the following meanings:

-  Button allows you to perform the following actions:
 - Input parameter in edit mode,
 - Enter of changes in parameter
 - Change the format or display the current phase (transition from relative to absolute values)
-  Button is used to resign from the selected setting value before entering it.
-  Buttons allow you to move the controller functions and parameter editing mode, allow you to change its value.
- 

PARAMETER

To set the working parameters of the relay is the menu system, whose structure is shown in picture 5

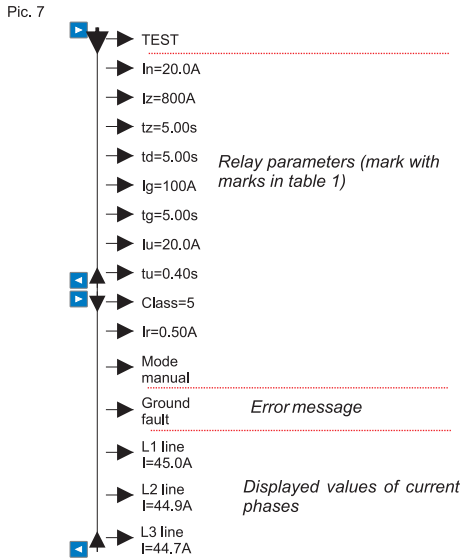

Menu structure of relay EPS-D

The display of device in a legible and conveniently presents data on the actual current values of each phase. At the same time can be displayed the current value of one phase, but it can be displayed in absolute bezwzględnych (Amperes) (Pic. 5), or relative terms (percentages in relation to the preset value of rated current) (Pic. 6).

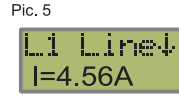

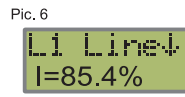

Indication of absolute current values



Indication of relative current values

In addition, up to date with the symbols are presented information about the field in which the measured current.

-  Too high value of the current work - more than 105% of preset rated current.
-  The correct value of the current work - the amount of current is in the range from 95% to 105% of rated current.
-  Too low value of the current work - less than 95% of preset rated current.



Relay performs the measurement of real value to the seventh harmonic current inclusive. Current measurement is performed with an precision of $\pm 1\%$. Indicated value of current is value indicative and may not be used for current measurement, replacing the meters for this.

With adjustment of the parameters of the relay course of conduct in force following:

- Using the buttons choose from the menu select function (functions are transferred sequentially, from first to last, accordance with the model shown in picture 7)
 - Once you find the actual function shall adopt its choice by pressing the **OK** button.
 - If is selected the function which is corresponding by settings of one of the parameters of the relay, then using the buttons \leftarrow or \rightarrow we can choose one of the possible values of the parameter.
- ATTENTION!**
Changes in the value parameter shall follow the jump for editing the appropriate parameters (Table 1). This means that the push of a button \leftarrow or \rightarrow causes a reduction/increase in value of parameter not by one individual, but the volume of the corresponding jump of the parameter.
- After setting a new value of parameter, enter it by pressing the **OK** button.
- If you do not want the changes will saved in the memory of the relay, press the **ESC** button. Sample the course of investigations is shown in picture 9.

Change the value of further parameters need to repeat the above sequence of operations.
If selected function to display a current of one phase, then the display will be shown the current value of current flowing in the phase. Pressing the **OK** button is used in this case to change the current format or display (switches between displaying the absolute value and relative) of current phase

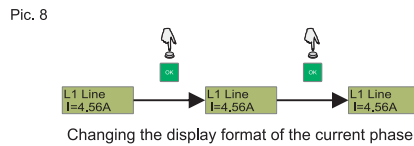

Changing the display format of the current phase



Example of changes in the value of the current of residual-current protection that at the time of the initial value the relay display current L1 phase, should be tripled press <- and get in this way to display the values for Ir. To pass the edit mode should now press the **OK** button. Then, by pressing or holding down the button <- inclined appropriate value of protection - in this case is the value of 0.03 mA. If you want to save the change, then press the **OK** button. On display will be shown a new value of parameter. If you want to cancel your changes, then press **ESC** button and then the display shows an earlier version of the parameter Ir.

Pic. 9

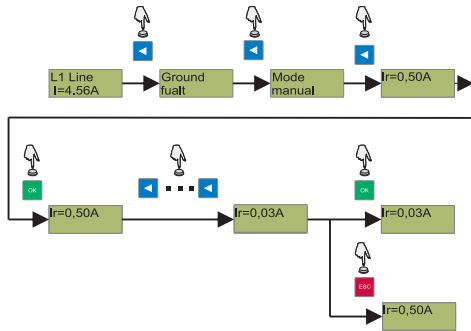

Example of change value of parameter Ir



2) Return of the relay to work is possible after a period of approximately 5 seconds after finding the relay that the engine temperature measured using the thermistor is located in the right range. If you work in **manual** mode should be on lowering the temperature, press the **OK** button when viewing the message. If the message does not appear on the display should be using the <- or -> button to find it at one of the menus and then press **OK** button. When you work in **auto** mode to return to work make automatically.

Short fault³⁾

Signaling response short-circuit protection

Ground fault³⁾

Signaling response ground-short-circuit protection.

Under fault³⁾

Signaling response under-current protection

Phase fault³⁾

Signaling decay phase, or asymmetry currents greater than 30%.

Sequence fault³⁾

Signaling wrong phase sequence.



3) Return of the relay to work is made by pressing the **OK** button. Work mode of the relay has no effect on the behavior of the relay at these functions.

COMMUNICATIONS

Cases of security response, or power failure the user is informed via messages on the screen of relay. Follow presented a list of possible messages and how to deal with as they arise.

R-phase overheat¹⁾

Signaling overheating of engine due to flowing current in the phase R.

S-phase overheat¹⁾

Signaling overheating of engine due to flowing current in the phase S.

T-phase overheat¹⁾

Signaling overheating of engine due to flowing current in the phase T.



1) Return of the relay to work is possible at lower simulated temperatures by 20% compared to the rated temperature. If you work in manual mode should be on lowering the temperature, press the **OK** button when viewing the message. If the message does not appear on the display should be using the <- or -> button to find it at one of the menus and then press **OK**. When you work in auto mode to return to work make automatically.

Motor overheat²⁾

Signaling overheating of engine registered by thermistor sensor

Power fault⁴⁾

Signaling of short-term power failure of relay



4) This message is displayed after the return of the relay if the power loss of power was not longer than ten minutes. If the loss of the power system has not identified any failures that automatically returns the relay to work. Data about state heat engine (simulated) after the return of power will be automatically updated. If the power interruption was longer than tens of minutes, after the return of the power state of the relay is reset.



Relay settings are always maintained, independent of the state powersupply of relay.

START-UP

1. Take OFF the power supply.
2. Set the parameters of the relay in accordance with the guidelines outlined in the project and the installation instructions in this manual.
3. Make start of engine.
4. If necessary, correct setting of current I_n to match it to the actual of working current of the engine.

ATTENTION!

In automatic mode, after an emergency operation the engine is shut its self will attach. If this situation poses a threat to the attendants, and it is not possible to set the manual mode, you must prevent access by persons to the hedged engine or clearly labeled place risks visible and clear information about the danger.

**TECHNICAL DATA**

Power supply	230V, 50/60Hz
Main circuits' insulation voltage	690V~
Rated current (In)	see label on EPS case
Main circuits' frequency	50Hz
Main circuits' protection (2-A fuses, char. gG)	3×In, char. gG 2A at 400V~ DC-15 2A at 30V- DC-14
Insulation co-ordination type	2
Protection level	IP20
Material group	II
Surge voltage _{1,2/50}	main circuit 8kV auxiliary circuit (95-96) 4kV
Overvoltage category	- II (load level)
Effective current unbalance	>30%
Delay at phase decay and unbalance	4sec.
Pollution level	3
Rated duty type	class 30, rel. time 40%
Max. cable diameter	Ø14
Terminal	screw terminals 1×2,5 mm
Measurements	72×59×88 mm
Weight	385g
Fixing	on rail TH-35

WARRANTY

1. The duration of the warranty is 24 months from the date of purchase.
2. The warranty is valid with the receipt only.
3. Complaints must be filed at the point of purchase or directly with the producer (tel. no. 42-2270971, e-mail: dztech@fif.com.pl).
4. Within the warranty period, the producer undertakes to repair or replace the relay within 14 days from the date the unit is delivered to the service point.
5. The purchaser has the right to have the relay replaced or to receive a refund if an indelible defect is revealed.
6. This warranty does not cover the following:
 - mechanical or chemical defects,
 - defects which stem from improper use contrary to the user's manual,
 - defects which appear after the unit has been sold due to accidents or other events for which neither the producer nor the point of sale can be held responsible, e.g. transport damage, etc.
7. This warranty does not cover any operations which, according to the manual, should be done by the user, e.g. mounting of the relay, installation of the electrical system, installation of other required electrical protection devices, recommended inspections and tests, etc.

ATTENTION!

No unauthorised modifications are to be made in the relay otherwise the device may be damaged or malfunction which in turn may lead to damage of the protected engine and jeopardise its operators. Should this warning be ignored, the producer cannot be held responsible for any related events and is entitled to deem this warranty invalid in the case of any complaint.

ATTENTION!

1. MEMORY RESET ESC + POWER OFF
2. PHASE SEQUENCE FUNCTION
In the case of incorrect connection string is displayed SEQUENY FAULT, you must turn to each other 2 wires through the holes of the relay
3. SETUP
Set on the display L3 and Press simultaneously ESC and OK for 1s
4. BLOCKING
Set on the display L1 and press simultaneously ESC and OK for 1s
5. FREQUENCY should be set on 50Hz
Additional settings (ID = 40 and EPS-identification working group, RCD TEST test Ferranti transformers if they are connected, otherwise the output should remain closed).