

DATA SHEET



rH-P1

Battery motion sensor
of the F&Home RADIO system

The rH-P1 module is a low current passive motion sensor. The sensor detects a person by registering changes in infrared radiation. Each change is transmitted to the system. Communication with the server is done via radio. Typical applications include lighting control, ventilation control and operation in the security system.

The rH-P1 module is represented by an object, which consists of one input and one output of the binary motion sensor. The detection of a person generates a logical state of '1' on the output. In idle mode, the output is the logical state '0'.

INPUTS		
Figure	Name	Type
	Channel 1	binary

OUTPUTS		
Figure	Name	Type
	presence detection	binary
	Error number	byte

If you connect any element to a binary input of the object, then the signal from this element will be accumulated with the signal from the motion sensor and shared at the output "Presence detection".

Errors returned by the "error" output	
Number	Error description
1	Network error
2	Module failure
4	Module out of reach
8	Module duplicate
16	Battery low
32	Module overheating
64	Module overload
128	Logical state "1" by 24 hours

PLEASE NOTE! We get logical sum of all current states on the output

Use the touch icon 707 "touch button byte display" to display the error code.

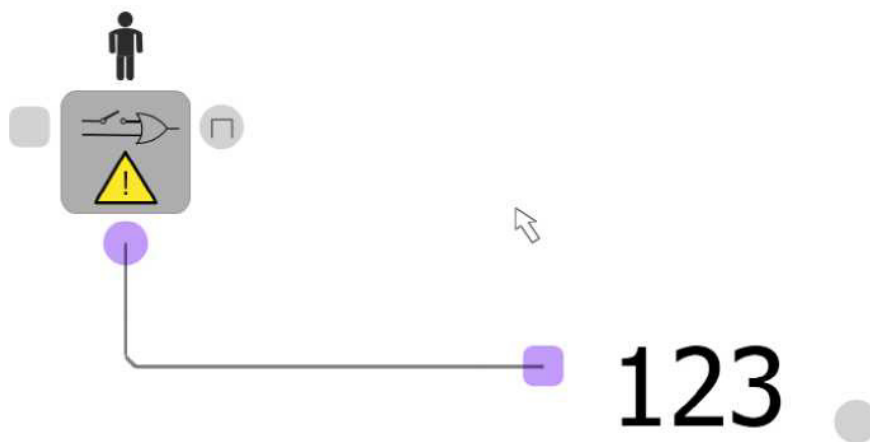

Installer settings in the configuration program

Feature name	Description	Range	Unit / Description
Connection monitoring	Sets action in case of loss of connection to the server (information about the modules out of reach).	Standard module	Information on the standard output SX 752
		Alarm module	Information on the alarm output SX 752
		Unmonitored module	No connection correctness control
The delay in signaling a lack of coverage	Sets the delay after which the module is reported that it is beyond the coverage range of the server	1 - 5	
Alarm arming delay	Sets the time after which the alarm will be armed	0-60	second
Alarm disarming delay	Sets the time in which the alarm must be disarmed	0-60	second
Maximum activity time (0 - 24 hours)	Sets the time after which the output status will be changed to logical state '0'. For time 0 the logical state is changed at the output after 24 h.	0 - 600	second

The motion sensor can operate in one of two modes, selected in the context menu or when you drop an element on the project.

Object type			
scheme		mode	description
		No alarm	In this mode the module operates in a classified manner (without connection) only with the presence controller SX 702. Warning! Alarm operation delay settings are active, but do not affect the operation of the alarm system.
		Alarm	The mode used in the alarm system. In this mode, each sensor placed in the project operates in a classified manner (without connection) with the alarm controller SX 600 and the presence controller SX 702.

Recommendations for module installation

Description

Figure

The motion sensor should not be installed in front of windows or in places directly exposed to the sun

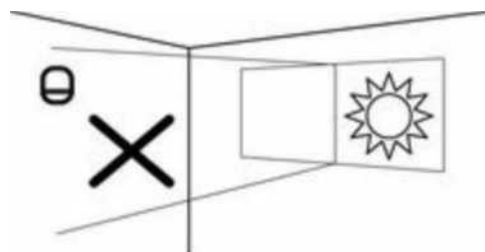

Make sure that right in front of the sensor or in its field of view (coverage area) is free of partitions (flowers, furniture, partitions) that prevent its proper operation

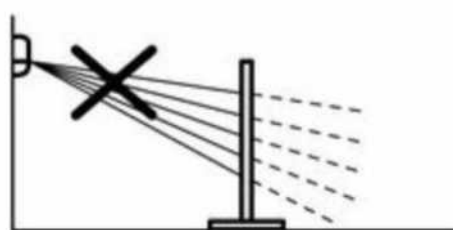

It is not recommended to mount the sensor in the vicinity of equipment that could alter the ambient temperature in a violent manner, for example radiators and air



The sensor should be mounted on a rigid surface, at a minimum height of 2.4 m

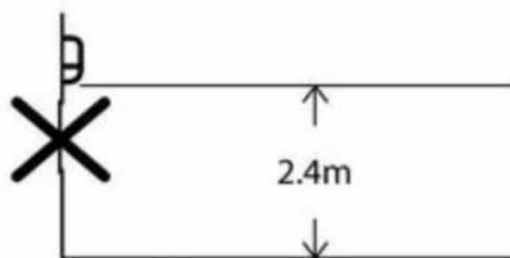

The motion sensor has a greater sensitivity to movement across the detection zone rather than in the direction of the sensor

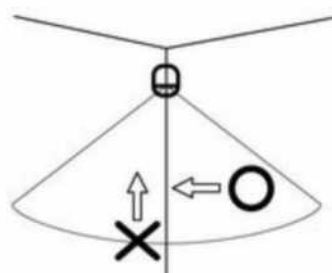

Detection area

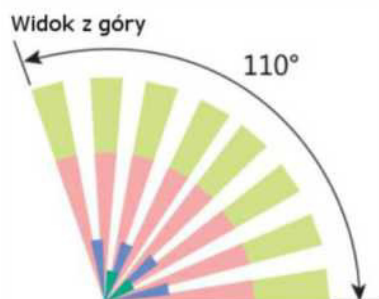

Widok z góry - View from above

Widok z boku



Widok z boku - View from a side

Installation

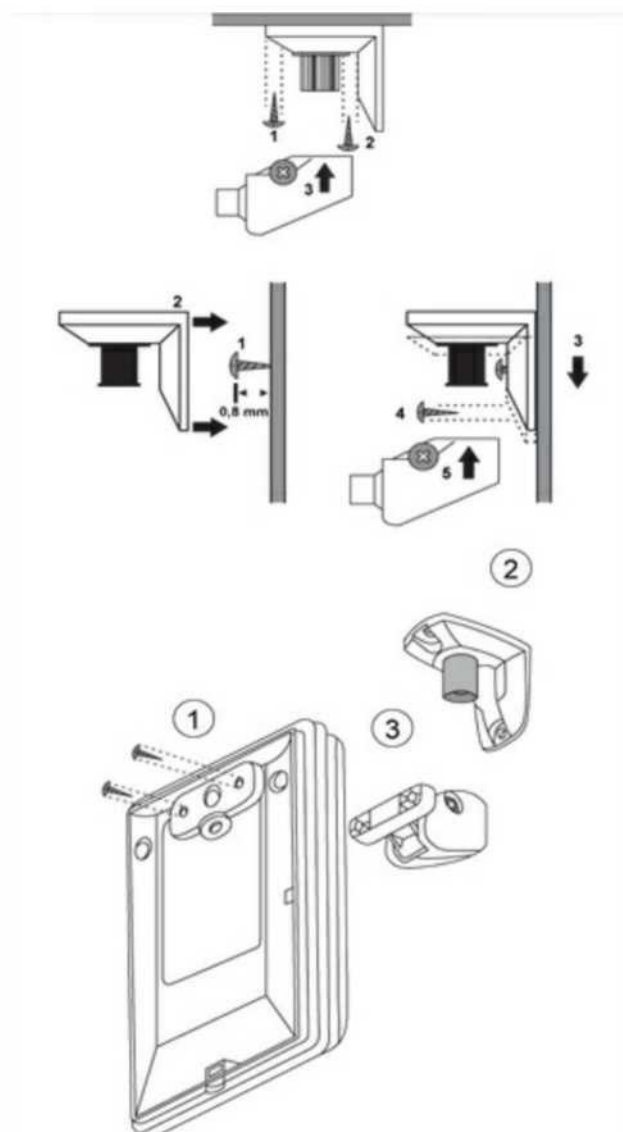

- Unscrew the sensor housing
- Unscrew and remove the electronics board
- Using two screws fasten the back cover of the detector to the joint
- Install the electronics board
- Remove the protective film from the battery
- Screw together the sensor housing
- Install wall-mounting bracket according to the diagram

Technical specifications table	
Power supply battery	2 x AAA
Battery operation time	12 - 36 months (depending on the battery)
Radio link (operating frequency)	868 MHz
Signal strength	9 mW
Transmission type	one-way with confirmation
Coding	yes
Range in open space	100 m
Period of logging in the system	up to 5 minutes
Motion sensor detection area	110°, 15m
Detection size	18 kg, 60 cm
Storing temperature	-20°C to +50°C
Working temperature	-20°C, +45°C
Humidity	≤85% (without condensation and aggressive gases)
Dimensions	112 x 66 x 45 mm
Ingress protection	IP20
Operating position	any
Enclosure type	free-standing / wall mounting
The hardware dead-time of the motion sensor	4 seconds
Battery monitoring	yes

Registration in the system

1. Unscrew the motion sensor housing cover and insert the battery according to specified polarity.
2. Select the registration method.
3. Close and screw together the cover of the housing.
4. Registration will take place immediately, and in case of failure the program reports an error.

WARNING

The connection method is specified in this manual. Any activities related to installation, connection and regulation should be carried out by persons with electrical qualifications who are familiar with this manual and features of the module. Manner of transport, storing and using the module affects its proper operation. Installation of the module is not recommended in the following cases: missing components, damage to the module or its deformation. In case of malfunction the module should be returned to the manufacturer.